

## LM4810 Boomer® Audio Power Amplifier Series

### Dual 105mW Headphone Amplifier with Active-High Shutdown Mode

Check for Samples: [LM4810](#)

#### FEATURES

- Active-High Shutdown Mode
- WSON, VSSOP, and SOIC Surface Mount Packaging
- "Click and Pop" Suppression Circuitry
- Low Shutdown Current
- No Bootstrap Capacitors Required
- Unity-Gain Stable

#### APPLICATIONS

- Cellular Phones
- Personal Computers
- Microphone Preamplifier
- PDA's

#### KEY SPECIFICATIONS

- THD+N at 1kHz, 105mW Continuous Average Power into 16Ω 0.1 % (typ)
- THD+N at 1kHz, 70mW Continuous Average Power into 32Ω 0.1 % (typ)
- Shutdown Current 0.4 μA (typ)

#### DESCRIPTION

The LM4810 is a dual audio power amplifier capable of delivering 105mW per channel of continuous average power into a 16Ω load with 0.1% (THD+N) from a 5V power supply.

Boomer audio power amplifiers were designed specifically to provide high quality output power with a minimal amount of external components. Since the LM4810 does not require bootstrap capacitors or snubber networks, it is optimally suited for low-power portable systems.

The unity-gain stable LM4810 can be configured by external gain-setting resistors.

The LM4810 features an externally controlled, active-high, micropower consumption shutdown mode, as well as an internal thermal shutdown protection mechanism.



Please be aware that an important notice concerning availability, standard warranty, and use in critical applications of Texas Instruments semiconductor products and disclaimers thereto appears at the end of this data sheet.

All trademarks are the property of their respective owners.

## Typical Application

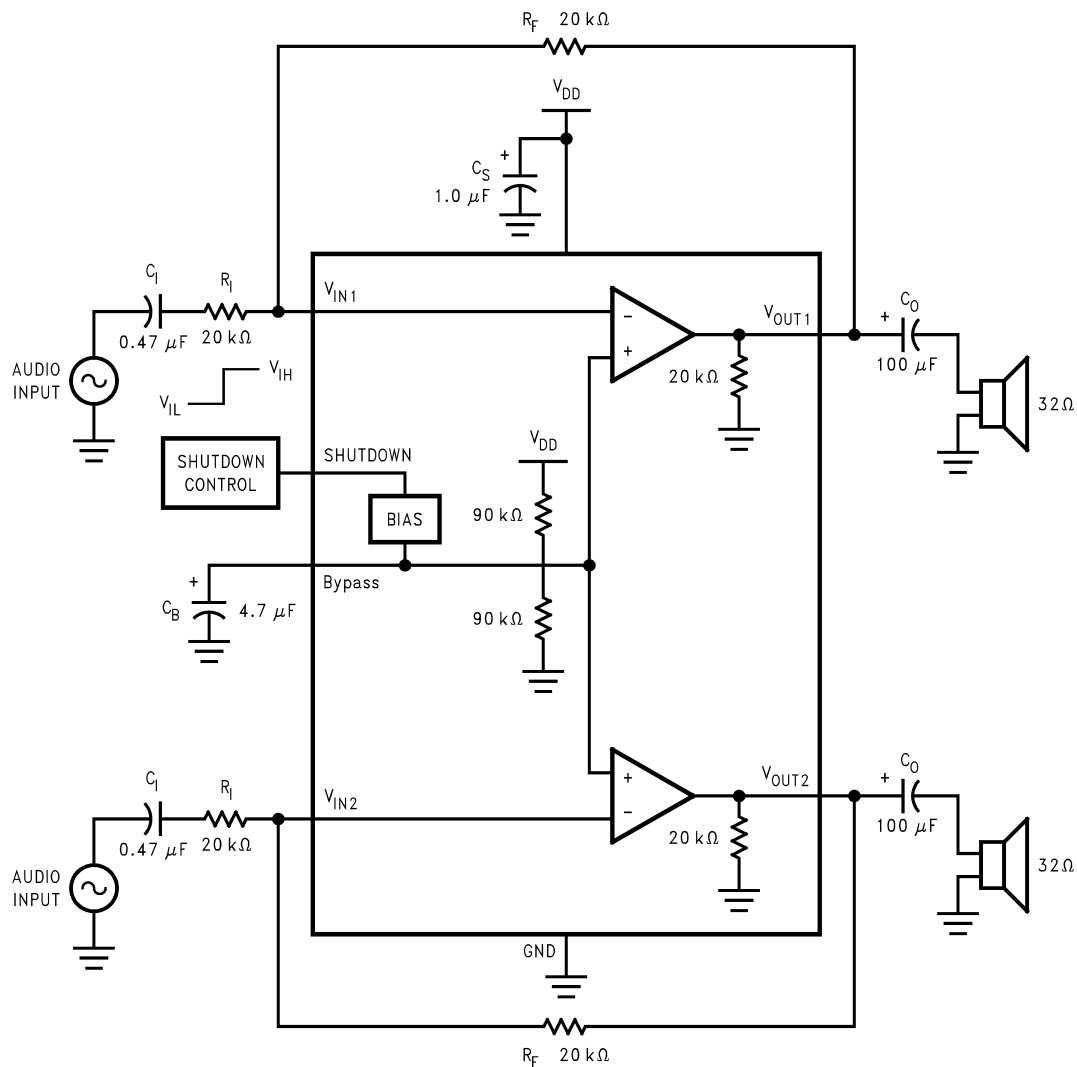

\*Refer to [Application Information](#) for information concerning proper selection of the input and output coupling capacitors.

**Figure 1. Typical Audio Amplifier Application Circuit**

Connection Diagrams

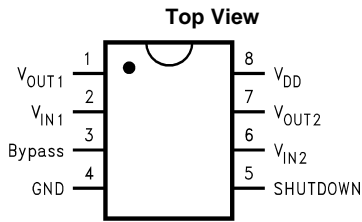

Figure 2. VSSOP Package  
See Package Number DGK0008A

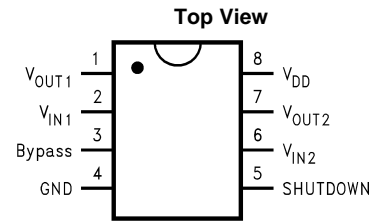

Figure 3. SOIC Package  
See Package Number D0008A

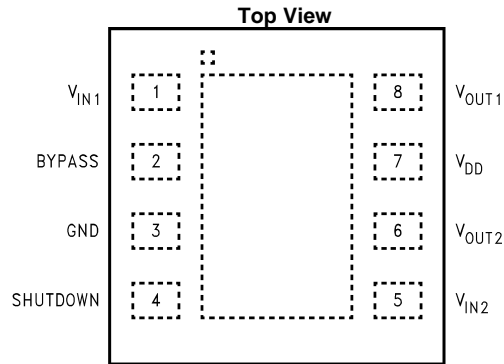

Figure 4. WSON Package  
See Package Number NGL0008B



These devices have limited built-in ESD protection. The leads should be shorted together or the device placed in conductive foam during storage or handling to prevent electrostatic damage to the MOS gates.

### Absolute Maximum Ratings <sup>(1)(2)</sup>

|  |                         |                        |       |
|--|-------------------------|------------------------|-------|
| Supply Voltage                         |                         | 6.0V                   |       |
| Storage Temperature                    |                         | -65°C to +150°C        |       |
| ESD Susceptibility <sup>(3)</sup>      |                         | 3.5kV                  |       |
| ESD Machine Model <sup>(4)</sup>       |                         | 250V                   |       |
| Junction Temperature (T <sub>J</sub> ) |                         | 150°C                  |       |
| Soldering Information                  | SOIC Package            | Vapor Phase (60 sec.)  | 215°C |
|  |                         | Infrared (15 sec.)     | 220°C |
| Thermal Resistance                     | θ <sub>JA</sub> (SOIC)  | 170°C/W                |       |
|  | θ <sub>JC</sub> (SOIC)  | 35°C/W                 |       |
|  | θ <sub>JA</sub> (VSSOP) | 210°C/W                |       |
|  | θ <sub>JC</sub> (VSSOP) | 56°C/W                 |       |
|  | θ <sub>JA</sub> (WSON)  | 117°C/W <sup>(5)</sup> |       |
|  | θ <sub>JC</sub> (WSON)  | 150°C/W <sup>(6)</sup> |       |
|  | θ <sub>JA</sub> (WSON)  | 150°C/W <sup>(6)</sup> |       |
|  | θ <sub>JC</sub> (WSON)  | 15°C/W                 |       |

- (1) *Absolute Maximum Ratings* indicate limits beyond which damage to the device may occur.
- (2) Military/Aerospace specified devices are required, please contact the Texas Instruments Sales Office/ Distributors for availability and specifications.
- (3) Human body model, 100pF discharged through a 1.5kΩ resistor.
- (4) Machine Model ESD test is covered by specification EIAJ IC-121-1981. A 200pF cap is charged to the specified voltage, then discharged directly into the IC with no external series resistor (resistance of discharge path must be under 50Ω).
- (5) The given θ<sub>JA</sub> is for an LM4810 packaged in an NGL0008B with the Exposed-Dap soldered to a printed circuit board copper pad with an area equivalent to that of the Exposed-Dap itself.
- (6) The given θ<sub>JA</sub> is for an LM4810 packaged in an NGL0008B with the Exposed-Dap not soldered to any circuit board copper.

### Operating Ratings <sup>(1)</sup>

|                                   |  |                               |
|-----------------------------------|--|-------------------------------|
| Temperature Range                 | T <sub>MIN</sub> ≤ T <sub>A</sub> ≤ T <sub>MAX</sub> | -40°C ≤ T <sub>A</sub> ≤ 85°C |
| Supply Voltage (V <sub>CC</sub> ) |  | 2.0V ≤ V <sub>CC</sub> ≤ 5.5V |

- (1) *Absolute Maximum Ratings* indicate limits beyond which damage to the device may occur.

### Electrical Characteristics <sup>(1)(2)</sup>

The following specifications apply for V<sub>DD</sub> = 5V unless otherwise specified, limits apply to T<sub>A</sub> = 25°C.

| Parameter       | Test Conditions           | LM4810   |                      | Units (Limits) |         |
|-----------------|---------------------------|--|----------------------|----------------|---------|
|                 |                           | Typ <sup>(3)</sup>   | Limit <sup>(4)</sup> |                |         |
| V <sub>DD</sub> | Supply Voltage            |  | 2.0                  | V (min)        |         |
|                 |                           |  | 5.5                  | V (max)        |         |
| I <sub>DD</sub> | Supply Current            | V <sub>IN</sub> = 0V, I <sub>O</sub> = 0A                        | 1.3                  | 3              | mA(max) |
| I <sub>SD</sub> | Shutdown Current          | V <sub>IN</sub> = 0V, V <sub>SHUTDOWN</sub> = V <sub>DD</sub>    | 0.4                  | 2              | μA(max) |
| V <sub>OS</sub> | Output Offset Voltage     | V <sub>IN</sub> = 0V   | 4.0                  | 50             | mV(max) |
| P <sub>O</sub>  | Output Power              | THD+N = 0.1%, f = 1kHz   |                      |                |         |
|                 |                           | R <sub>L</sub> = 16Ω   | 105                  |                | mW      |
|                 |                           | R <sub>L</sub> = 32Ω   | 70                   | 65             | mW(min) |
| THD+N           | Total Harmonic Distortion | P <sub>O</sub> = 50mW, R <sub>L</sub> = 32Ω<br>f = 20Hz to 20kHz | 0.3                  |                | %       |
| Crosstalk       | Channel Separation        | R <sub>L</sub> = 32Ω; P <sub>O</sub> = 70mW                      | 70                   |                | dB      |

- (1) *Absolute Maximum Ratings* indicate limits beyond which damage to the device may occur.
- (2) All voltages are measured with respect to the ground pin, unless otherwise specified.
- (3) Typical specifications are specified at +25°C and represent the most likely parametric norm.
- (4) Datasheet max/min specification limits are ensured by design, test, or statistical analysis.

### Electrical Characteristics <sup>(1)(2)</sup> (continued)

The following specifications apply for  $V_{DD} = 5V$  unless otherwise specified, limits apply to  $T_A = 25^\circ C$ .

| Parameter  |                              | Test Conditions   | LM4810             |                      | Units (Limits) |
|------------|------------------------------|---|--------------------|----------------------|----------------|
|            |                              |   | Typ <sup>(3)</sup> | Limit <sup>(4)</sup> |                |
| PSRR       | Power Supply Rejection Ratio | $C_B = 1.0\mu F$ ; $V_{RIPPLE} = 200mV_{PP}$ ,<br>$f = 1kHz$ ; Input terminated into $50\Omega$ | 70                 |                      | dB             |
| $V_{SDIH}$ | Shutdown Voltage Input High  |   |                    | $0.8 \times V_{DD}$  | V (min)        |
| $V_{SDIL}$ | Shutdown Voltage Input Low   |   |                    | $0.2 \times V_{DD}$  | V (max)        |

### Electrical Characteristics <sup>(1)(2)</sup>

The following specifications apply for  $V_{DD} = 3.3V$  unless otherwise specified, limits apply to  $T_A = 25^\circ C$ .

| Parameter  |                              | Test Conditions   | LM4810             |                      | Units (Limits) |
|------------|------------------------------|---|--------------------|----------------------|----------------|
|            |                              |   | Typ <sup>(3)</sup> | Limit <sup>(4)</sup> |                |
| $I_{DD}$   | Supply Current               | $V_{IN} = 0V$ , $I_O = 0A$  | 1.0                |                      | mA             |
| $I_{SD}$   | Shutdown Current             | $V_{IN} = 0V$ , $V_{SHUTDOWN} = V_{DD}$   | 0.4                |                      | $\mu A$        |
| $V_{OS}$   | Output Offset Voltage        | $V_{IN} = 0V$   | 4.0                |                      | mV             |
| $P_O$      | Output Power                 | THD+N = 0.1%, $f = 1kHz$  |                    |                      |                |
|            |                              | $R_L = 16\Omega$  | 40                 |                      | mW             |
|            |                              | $R_L = 32\Omega$  | 28                 |                      | mW             |
| THD+N      | Total Harmonic Distortion    | $P_O = 25mW$ , $R_L = 32\Omega$<br>$f = 20Hz$ to $20kHz$  | 0.4                |                      | %              |
| Crosstalk  | Channel Separation           | $R_L = 32\Omega$ ; $P_O = 25mW$   | 70                 |                      | dB             |
| PSRR       | Power Supply Rejection Ratio | $C_B = 1.0\mu F$ ; $V_{ripple} = 200mV_{PP}$ ,<br>$f = 1kHz$ ; Input terminated into $50\Omega$ | 70                 |                      | dB             |
| $V_{SDIH}$ | Shutdown Voltage Input High  |   |                    | $0.8 \times V_{DD}$  | V (min)        |
| $V_{SDIL}$ | Shutdown Voltage Input Low   |   |                    | $0.2 \times V_{DD}$  | V (max)        |

- (1) *Absolute Maximum Ratings* indicate limits beyond which damage to the device may occur.
- (2) All voltages are measured with respect to the ground pin, unless otherwise specified.
- (3) Typical specifications are specified at  $+25^\circ C$  and represent the most likely parametric norm.
- (4) Datasheet max/min specification limits are ensured by design, test, or statistical analysis.

### Electrical Characteristics <sup>(1)(2)</sup>

The following specifications apply for  $V_{DD} = 2.6V$  unless otherwise specified, limits apply to  $T_A = 25^\circ C$ .

| Parameter  |                              | Test Conditions   | LM4810             |                      | Units (Limits) |
|------------|------------------------------|---|--------------------|----------------------|----------------|
|            |                              |   | Typ <sup>(3)</sup> | Limit <sup>(4)</sup> |                |
| $I_{DD}$   | Supply Current               | $V_{IN} = 0V$ , $I_O = 0A$  | 0.9                |                      | mA             |
| $I_{SD}$   | Shutdown Current             | $V_{IN} = 0V$ , $V_{SHUTDOWN} = V_{DD}$   | 0.2                |                      | $\mu A$        |
| $V_{OS}$   | Output Offset Voltage        | $V_{IN} = 0V$   | 4.0                |                      | mV             |
| $P_O$      | Output Power                 | THD+N = 0.1%, $f = 1kHz$  |                    |                      |                |
|            |                              | $R_L = 16\Omega$  | 20                 |                      | mW             |
|            |                              | $R_L = 32\Omega$  | 16                 |                      | mW             |
| THD+N      | Total Harmonic Distortion    | $P_O = 15mW$ , $R_L = 32\Omega$<br>$f = 20Hz$ to $20kHz$  | 0.6                |                      | %              |
| Crosstalk  | Channel Separation           | $R_L = 32\Omega$ ; $P_O = 15mW$   | 70                 |                      | dB             |
| PSRR       | Power Supply Rejection Ratio | $C_B = 1.0\mu F$ ; $V_{ripple} = 200mV_{PP}$ ,<br>$f = 1kHz$ ; Input terminated into $50\Omega$ | 70                 |                      | dB             |
| $V_{SDIH}$ | Shutdown Voltage Input High  |   |                    | $0.8 \times V_{DD}$  | V (min)        |
| $V_{SDIL}$ | Shutdown Voltage Input Low   |   |                    | $0.2 \times V_{DD}$  | V (max)        |

- (1) *Absolute Maximum Ratings* indicate limits beyond which damage to the device may occur.
- (2) All voltages are measured with respect to the ground pin, unless otherwise specified.
- (3) Typical specifications are specified at  $+25^\circ C$  and represent the most likely parametric norm.
- (4) Datasheet max/min specification limits are ensured by design, test, or statistical analysis.

## External Components Description

| Components | Functional Description (See <a href="#">Figure 1</a> )  |
|------------|---|
| 1. $R_i$   | The inverting input resistance, along with $R_f$ , set the closed-loop gain. $R_i$ , along with $C_i$ , form a high pass filter with $f_c = 1/(2\pi R_i C_i)$ .   |
| 2. $C_i$   | The input coupling capacitor blocks DC voltage at the amplifier's input terminals. $C_i$ , along with $R_i$ , create a highpass filter with $f_c = 1/(2\pi R_i C_i)$ . Refer to <a href="#">SELECTING PROPER EXTERNAL COMPONENTS</a> , for an explanation of determining the value of $C_i$ . |
| 3. $R_f$   | The feedback resistance, along with $R_i$ , set closed-loop gain.   |
| 4. $C_S$   | This is the supply bypass capacitor. It provides power supply filtering. Refer to <a href="#">Application Information</a> for proper placement and selection of the supply bypass capacitor.  |
| 5. $C_B$   | This is the BYPASS pin capacitor. It provides half-supply filtering. Refer to <a href="#">SELECTING PROPER EXTERNAL COMPONENTS</a> for information concerning proper placement and selection of $C_B$ .   |
| 6. $C_O$   | This is the output coupling capacitor. It blocks the DC voltage at the amplifier's output and forms a high pass filter with $R_L$ at $f_o = 1/(2\pi R_L C_O)$   |

Typical Performance Characteristics

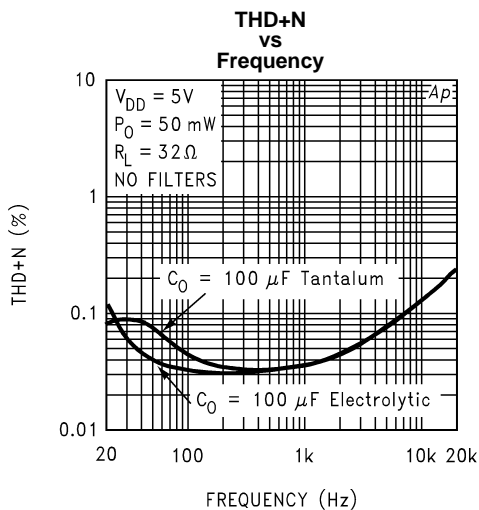

Figure 5.

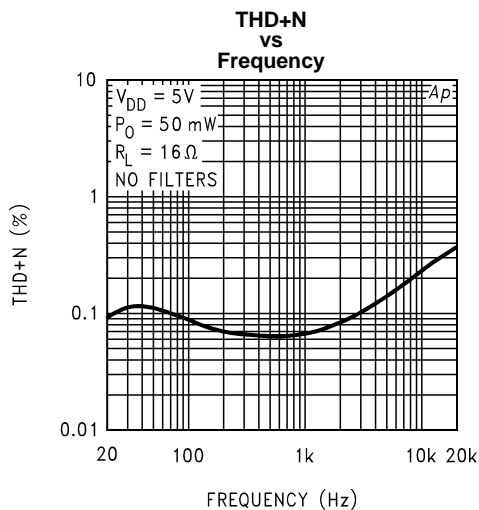

Figure 6.

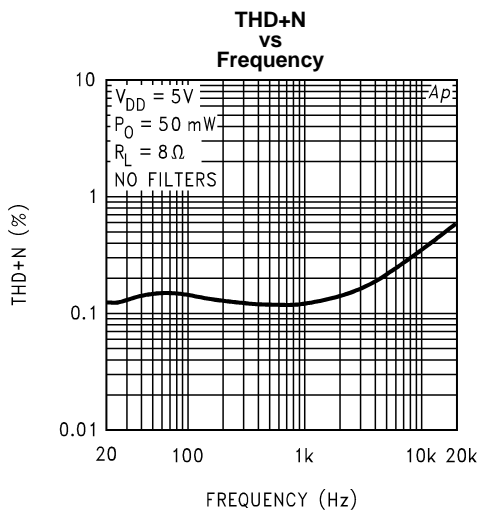

Figure 7.

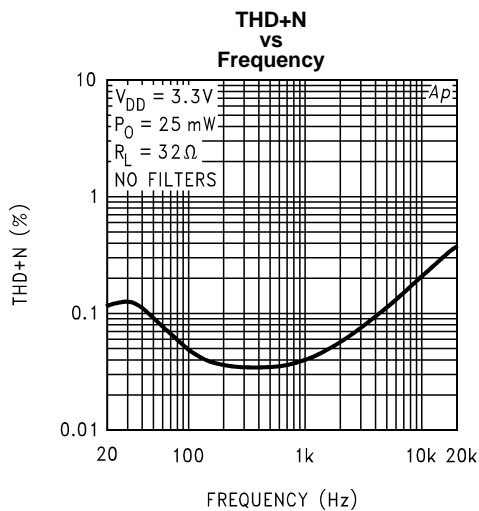

Figure 8.

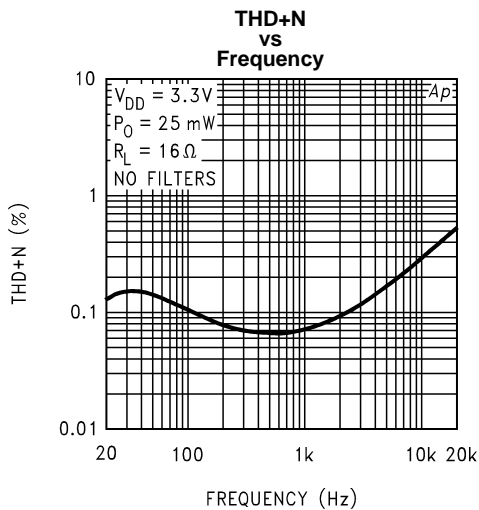

Figure 9.

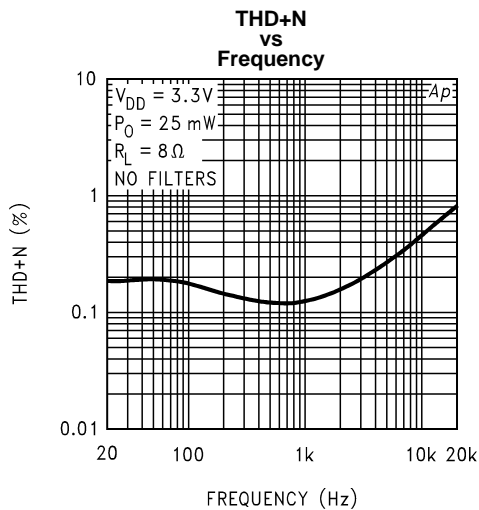

Figure 10.

Typical Performance Characteristics (continued)

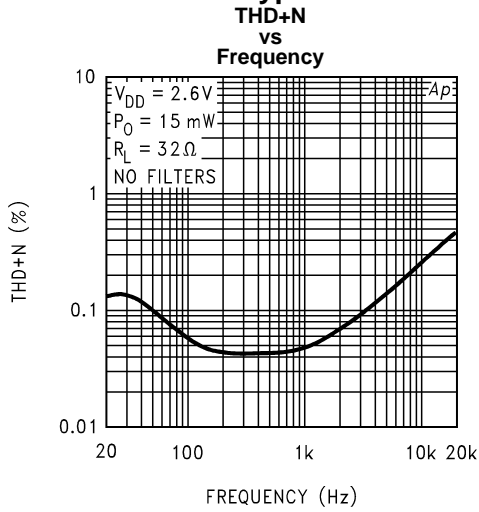

Figure 11.

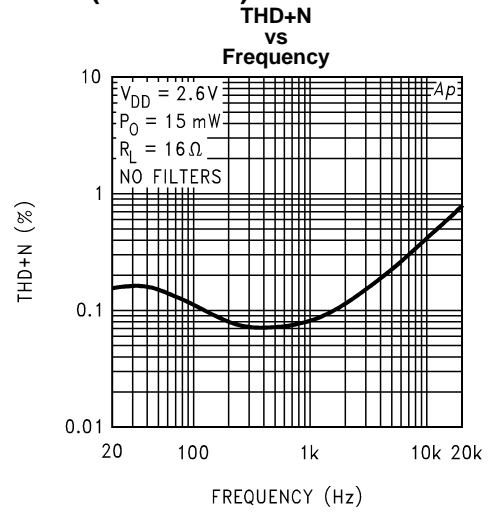

Figure 12.

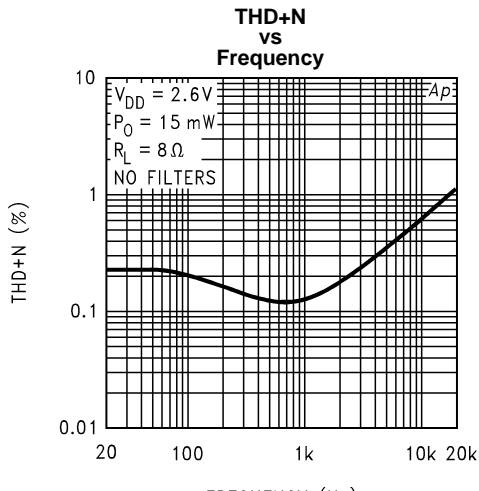

Figure 13.

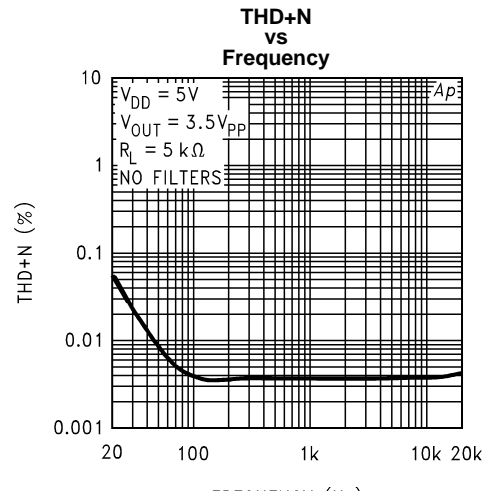

Figure 14.

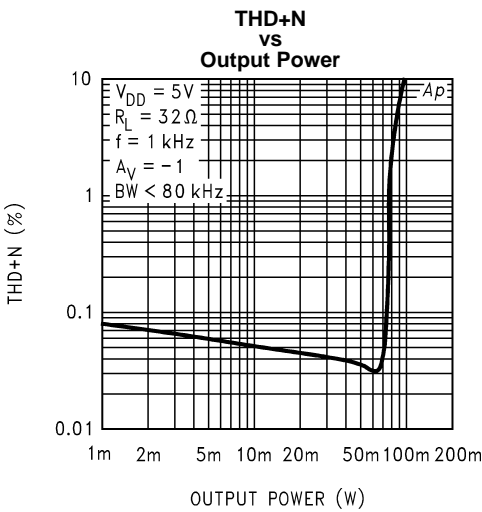

Figure 15.

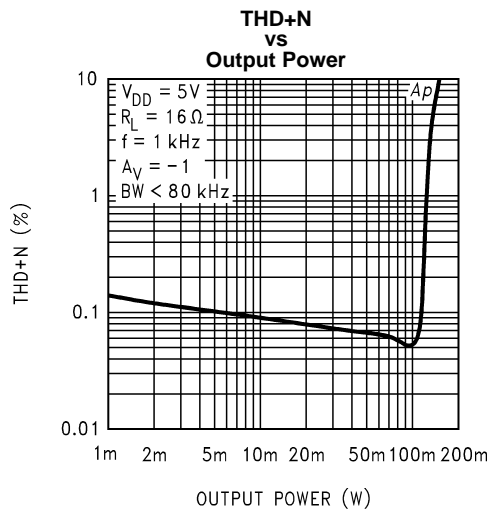
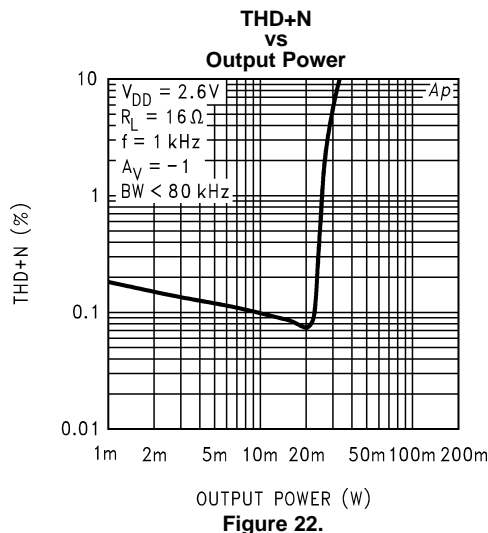
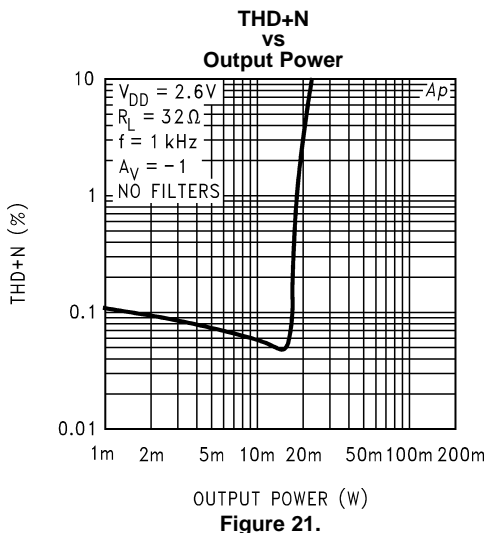
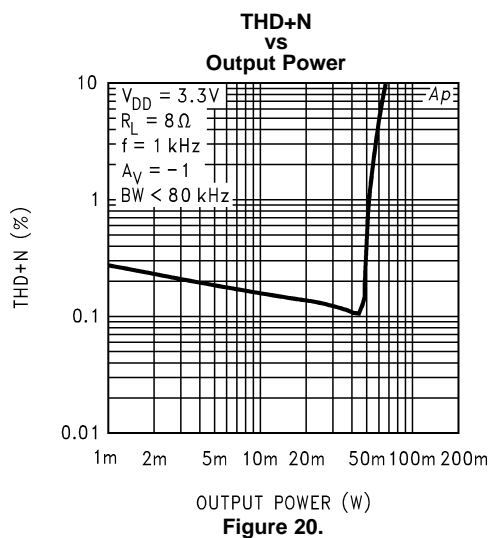
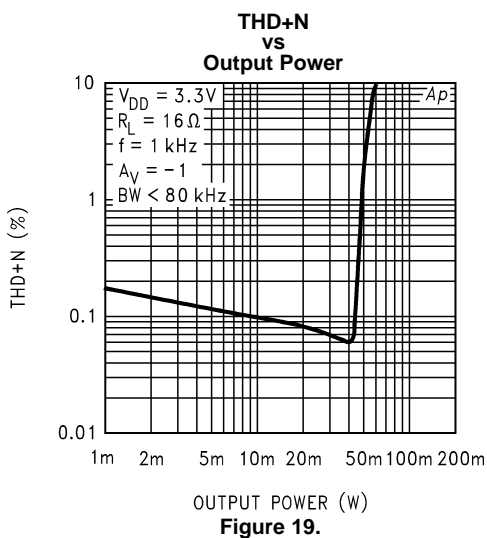
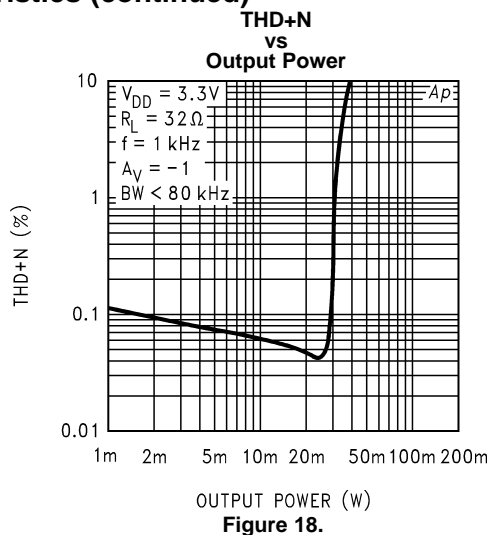
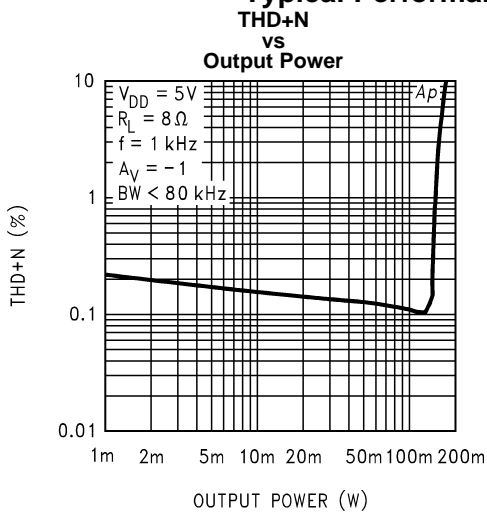

Figure 16.



Typical Performance Characteristics (continued)



**Typical Performance Characteristics (continued)**

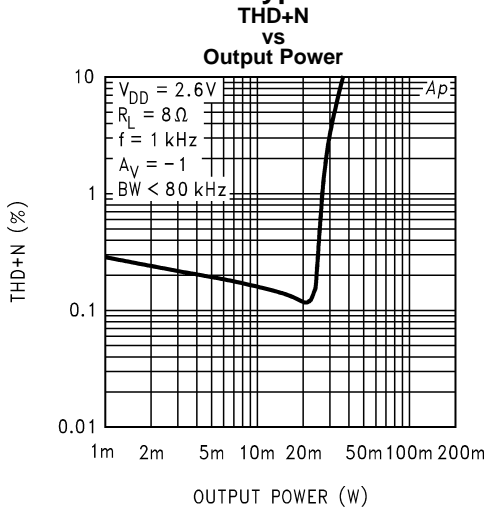

Figure 23.

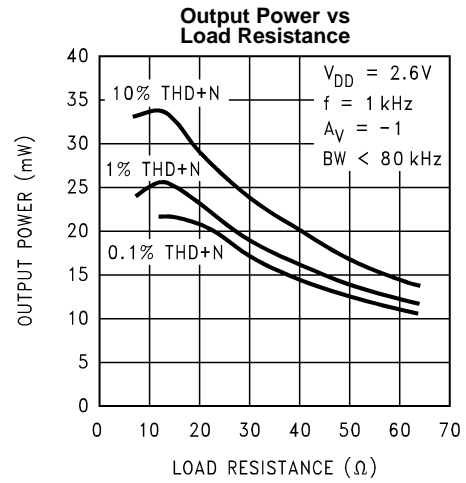

Figure 24.

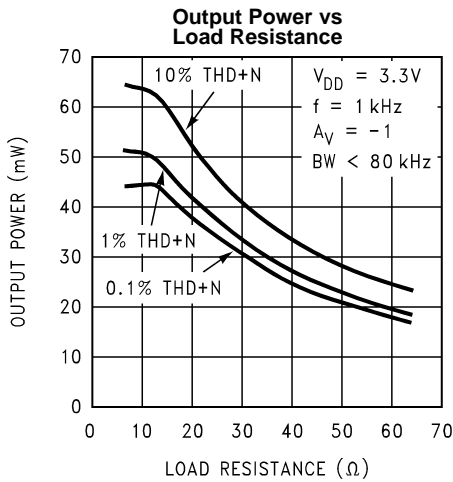

Figure 25.

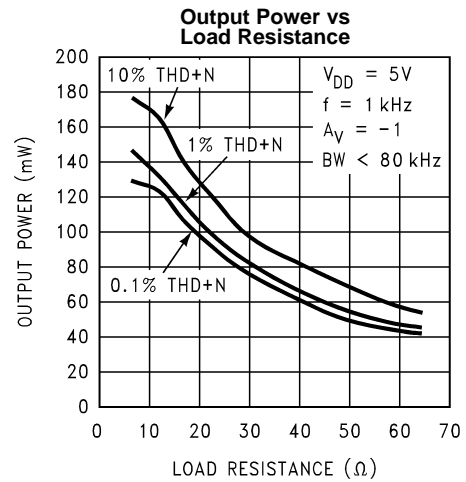

Figure 26.

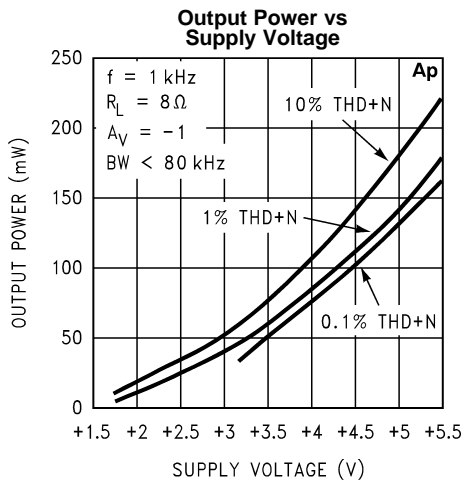

Figure 27.

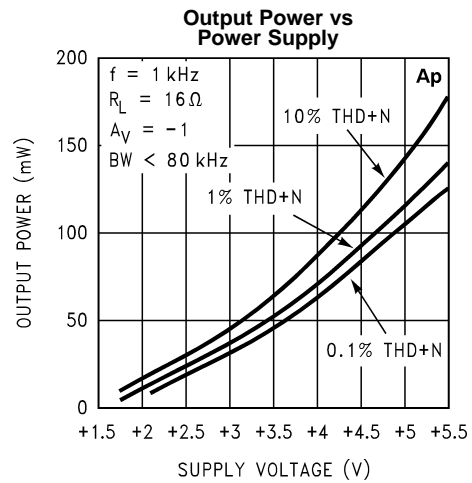

Figure 28.

Typical Performance Characteristics (continued)

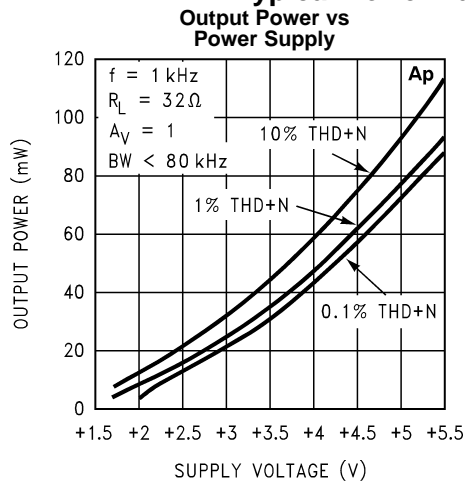

Figure 29.

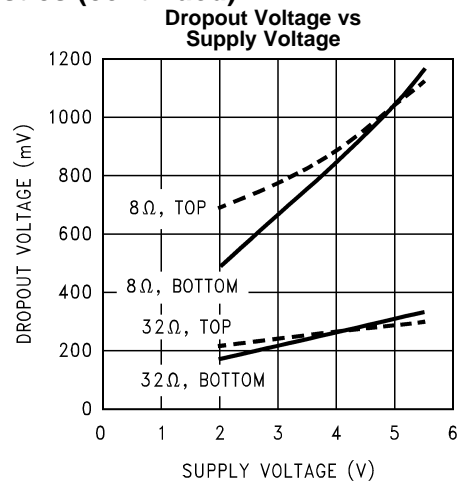

Figure 30.

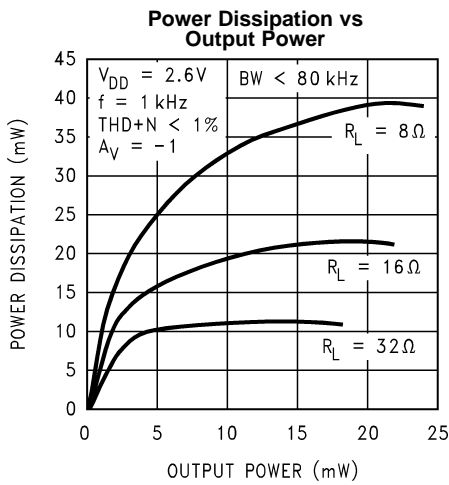

Figure 31.

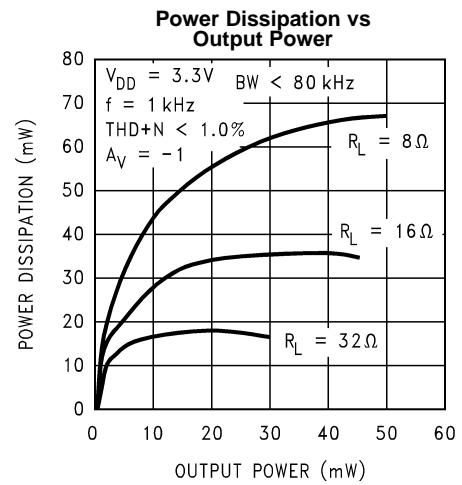

Figure 32.

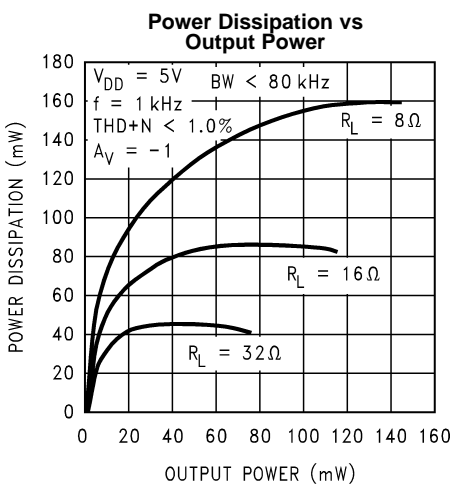

Figure 33.

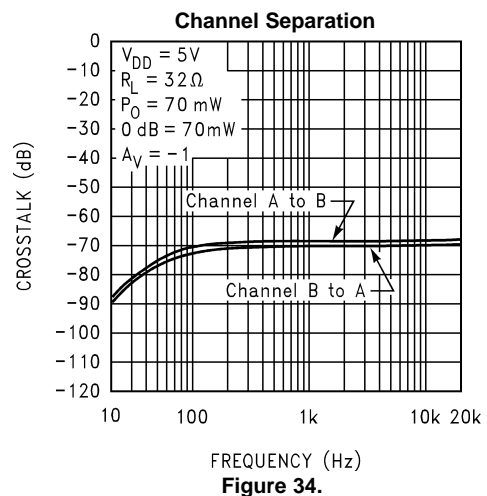

Figure 34.

**Typical Performance Characteristics (continued)**

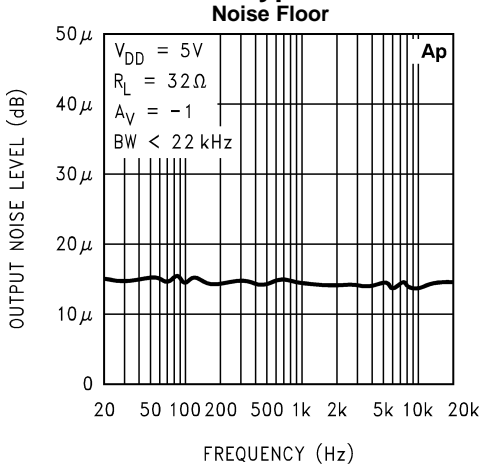

Figure 35.

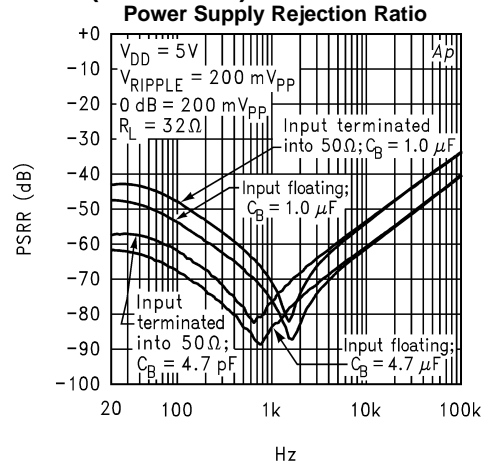

Figure 36.

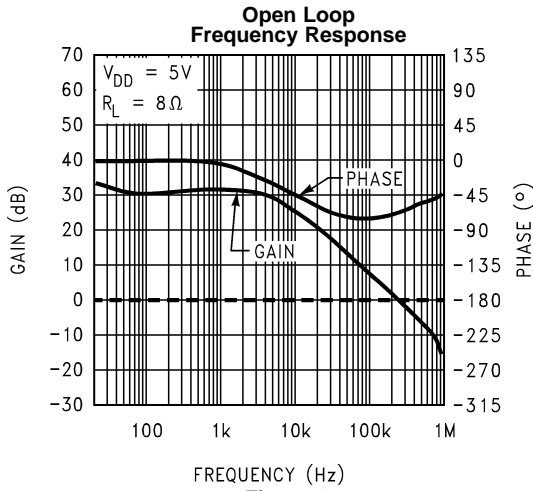

Figure 37.

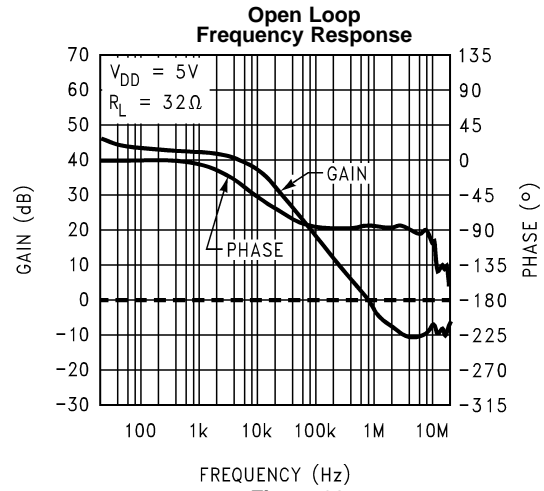

Figure 38.

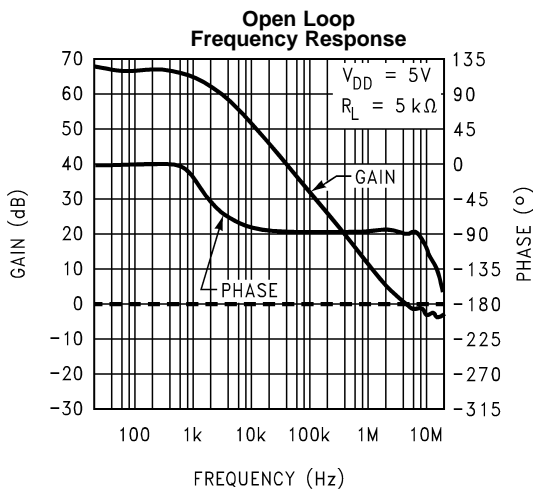

Figure 39.

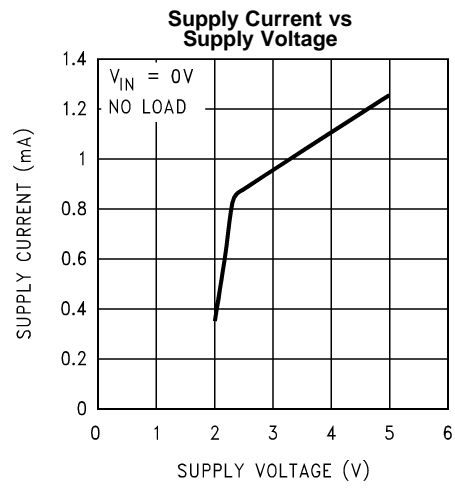

Figure 40.

## APPLICATION INFORMATION

### MICRO-POWER SHUTDOWN

The voltage applied to the SHUTDOWN pin controls the LM4810's shutdown function. Activate micro-power shutdown by applying a logic high voltage to the SHUTDOWN pin. The logic threshold is typically  $V_{DD}/2$ . When active, the LM4810's micro-power shutdown feature turns off the amplifier's bias circuitry, reducing the supply current. The low 0.4 $\mu$ A typical shutdown current is achieved by applying a voltage that is as near as  $V_{DD}$  as possible to the SHUTDOWN pin. A voltage that is less than  $V_{DD}$  may increase the shutdown current.

There are a few ways to control the micro-power shutdown. These include using a single-pole, single-throw switch, a microprocessor, or a microcontroller. When using a switch, connect an external 100k $\Omega$  pull-up resistor between the SHUTDOWN pin and  $V_{DD}$ . Connect the switch between the SHUTDOWN pin and GND. Select normal amplifier operation by closing the switch. Opening the switch connects the SHUTDOWN pin to  $V_{DD}$  through the pull-up resistor, activating micro-power shutdown. The switch and resistor ensure that the SHUTDOWN pin will not float. This prevents unwanted state changes. In a system with a microprocessor or a microcontroller, use a digital output to apply the control voltage to the SHUTDOWN pin. Driving the SHUTDOWN pin with active circuitry eliminates the pull-up resistor.

### EXPOSED-DAP PACKAGE PCB MOUNTING CONSIDERATION

The LM4810's exposed-Dap (die attach paddle) package (NGL0008B) provides a low thermal resistance between the die and the PCB to which the part is mounted and soldered. This allows rapid heat transfer from the die to the surrounding PCB copper traces, ground plane, and surrounding air.

The NGL0008B package should have its DAP soldered to a copper pad on the PCB. The DAP's PCB copper pad may be connected to a large plane of continuous unbroken copper. This plane forms a thermal mass, heat sink, and radiation area.

However, since the LM4810 is designed for headphone applications, connecting a copper plane to the DAP's PCB copper pad is not required. [Figure 33](#) in [Typical Performance Characteristics](#) shows that the maximum power dissipated is just 45mW per amplifier with a 5V power supply and a 32 $\Omega$  load.

Further detailed and specific information concerning PCB layout, fabrication, and mounting an NGL0008B (WSON) package is available from Texas Instruments' Package Engineering Group under application note AN1187.

### POWER DISSIPATION

Power dissipation is a major concern when using any power amplifier and must be thoroughly understood to ensure a successful design. [Equation 1](#) states the maximum power dissipation point for a single-ended amplifier operating at a given supply voltage and driving a specified output load.

$$P_{DMAX} = (V_{DD})^2 / (2\pi^2 R_L) \quad (1)$$

Since the LM4810 has two operational amplifiers in one package, the maximum internal power dissipation point is twice that of the number which results from [Equation 1](#). Even with the large internal power dissipation, the LM4810 does not require heat sinking over a large range of ambient temperature. From [Equation 1](#), assuming a 5V power supply and a 32 $\Omega$  load, the maximum power dissipation point is 40mW per amplifier. Thus the maximum package dissipation point is 80mW. The maximum power dissipation point obtained must not be greater than the power dissipation that results from [Equation 2](#):

$$P_{DMAX} = (T_{JMAX} - T_A) / \theta_{JA} \quad (2)$$

For package DGK0008A,  $\theta_{JA} = 210^\circ\text{C/W}$ .  $T_{JMAX} = 150^\circ\text{C}$  for the LM4810. Depending on the ambient temperature,  $T_A$ , of the system surroundings, [Equation 2](#) can be used to find the maximum internal power dissipation supported by the IC packaging. If the result of [Equation 1](#) is greater than that of [Equation 2](#), then either the supply voltage must be decreased, the load impedance increased or  $T_A$  reduced. For the typical application of a 5V power supply, with a 32 $\Omega$  load, the maximum ambient temperature possible without violating the maximum junction temperature is approximately 133.2 $^\circ\text{C}$  provided that device operation is around the maximum power dissipation point. Power dissipation is a function of output power and thus, if typical operation is not around the maximum power dissipation point, the ambient temperature may be increased accordingly. Refer to [Typical Performance Characteristics](#) for power dissipation information for lower output powers.

## POWER SUPPLY BYPASSING

As with any power amplifier, proper supply bypassing is critical for low noise performance and high power supply rejection. Applications that employ a 5V regulator typically use a 10 $\mu$ F in parallel with a 0.1 $\mu$ F filter capacitors to stabilize the regulator's output, reduce noise on the supply line, and improve the supply's transient response. However, their presence does not eliminate the need for a local 1.0 $\mu$ F tantalum bypass capacitance connected between the LM4810's supply pins and ground. Keep the length of leads and traces that connect capacitors between the LM4810's power supply pin and ground as short as possible. Connecting a 4.7 $\mu$ F capacitor,  $C_B$ , between the BYPASS pin and ground improves the internal bias voltage's stability and improves the amplifier's PSRR. The PSRR improvements increase as the bypass pin capacitor value increases. Too large, however, increases the amplifier's turn-on time. The selection of bypass capacitor values, especially  $C_B$ , depends on desired PSRR requirements, click and pop performance (as explained in [SELECTING PROPER EXTERNAL COMPONENTS](#)), system cost, and size constraints.

## SELECTING PROPER EXTERNAL COMPONENTS

Optimizing the LM4810's performance requires properly selecting external components. Though the LM4810 operates well when using external components with wide tolerances, best performance is achieved by optimizing component values.

The LM4810 is unity-gain stable, giving a designer maximum design flexibility. The gain should be set to no more than a given application requires. This allows the amplifier to achieve minimum THD+N and maximum signal-to-noise ratio. These parameters are compromised as the closed-loop gain increases. However, low gain demands input signals with greater voltage swings to achieve maximum output power. Fortunately, many signal sources such as audio CODECs have outputs of 1V<sub>RMS</sub> (2.83V<sub>P-P</sub>). Please refer to [AUDIO POWER AMPLIFIER DESIGN](#) for more information on selecting the proper gain.

### Input and Output Capacitor Value Selection

Amplifying the lowest audio frequencies requires high value input and output coupling capacitors ( $C_I$  and  $C_O$  in [Figure 1](#)). A high value capacitor can be expensive and may compromise space efficiency in portable designs. In many cases, however, the speakers used in portable systems, whether internal or external, have little ability to reproduce signals below 150Hz. Applications using speakers with this limited frequency response reap little improvement by using high value input and output capacitors.

Besides affecting system cost and size,  $C_i$  has an effect on the LM4810's click and pop performance. The magnitude of the pop is directly proportional to the input capacitor's size. Thus, pops can be minimized by selecting an input capacitor value that is no higher than necessary to meet the desired –3dB frequency. Please refer to the [OPTIMIZING CLICK AND POP REDUCTION PERFORMANCE](#) for a more detailed discussion on click and pop performance.

As shown in [Figure 1](#), the input resistor,  $R_I$  and the input capacitor,  $C_I$ , produce a –3dB high pass filter cutoff frequency that is found using [Equation 3](#). In addition, the output load  $R_L$ , and the output capacitor  $C_O$ , produce a –3db high pass filter cutoff frequency defined by [Equation 4](#).

$$f_{i-3db} = 1/2\pi R_I C_I \quad (3)$$

$$f_{o-3db} = 1/2\pi R_L C_O \quad (4)$$

Also, careful consideration must be taken in selecting a certain type of capacitor to be used in the system. Different types of capacitors (tantalum, electrolytic, ceramic) have unique performance characteristics and may affect overall system performance.

### Bypass Capacitor Value Selection

Besides minimizing the input capacitor size, careful consideration should be paid to the value of  $C_B$ , the capacitor connected to the BYPASS pin. Since  $C_B$  determines how fast the LM4810 settles to quiescent operation, its value is critical when minimizing turn-on pops. The slower the LM4810's outputs ramp to their quiescent DC voltage (nominally 1/2  $V_{DD}$ ), the smaller the turn-on pop. Choosing  $C_B$  equal to 4.7 $\mu$ F along with a small value of  $C_i$  (in the range of 0.1 $\mu$ F to 0.47 $\mu$ F), produces a click-less and pop-less shutdown function. As discussed above, choosing  $C_i$  no larger than necessary for the desired bandwidth helps minimize clicks and pops.

## OPTIMIZING CLICK AND POP REDUCTION PERFORMANCE

The LM4810 contains circuitry that minimizes turn-on and shutdown transients or “clicks and pop”. For this discussion, turn-on refers to either applying the power supply voltage or when the shutdown mode is deactivated. During turn-on, the LM4810’s internal amplifiers are configured as unity gain buffers. An internal current source charges up the capacitor on the BYPASS pin in a controlled, linear manner. The gain of the internal amplifiers remains unity until the voltage on the BYPASS pin reaches  $1/2 V_{DD}$ . As soon as the voltage on the BYPASS pin is stable, the device becomes fully operational. During device turn-on, a transient (pop) is created from a voltage difference between the input and output of the amplifier as the voltage on the BYPASS pin reaches  $1/2 V_{DD}$ . For this discussion, the input of the amplifier refers to the node between  $R_I$  and  $C_I$ . Ideally, the input and output track the voltage applied to the BYPASS pin. During turn-on, the buffer-configured amplifier output charges the input capacitor,  $C_I$ , through the input resistor,  $R_I$ . This input resistor delays the charging time of  $C_I$  thereby causing the voltage difference between the input and output that results in a transient (pop). Higher value capacitors need more time to reach a quiescent DC voltage (usually  $1/2 V_{DD}$ ) when charged with a fixed current. Decreasing the value of  $C_I$  and  $R_I$  will minimize the turn-on pops at the expense of the desired -3dB frequency.

Although the BYPASS pin current cannot be modified, changing the size of  $C_B$  alters the device’s turn-on time and the magnitude of “clicks and pops”. Increasing the value of  $C_B$  reduces the magnitude of turn-on pops. However, this presents a tradeoff: as the size of  $C_B$  increases, the turn-on time increases. There is a linear relationship between the size of  $C_B$  and the turn-on time. Here are some typical turn-on times for various values of  $C_B$ :

| $C_B$        | $T_{ON}$ |
|--------------|----------|
| 0.1 $\mu$ F  | 80ms     |
| 0.22 $\mu$ F | 170ms    |
| 0.33 $\mu$ F | 270ms    |
| 0.47 $\mu$ F | 370ms    |
| 0.68 $\mu$ F | 490ms    |
| 1.0 $\mu$ F  | 920ms    |
| 2.2 $\mu$ F  | 1.8sec   |
| 3.3 $\mu$ F  | 2.8sec   |
| 4.7 $\mu$ F  | 3.4sec   |
| 10 $\mu$ F   | 7.7sec   |

In order eliminate “clicks and pops”, all capacitors must be discharged before turn-on. Rapidly switching  $V_{DD}$  may not allow the capacitors to fully discharge, which may cause “clicks and pops”. In a single-ended configuration, the output is coupled to the load by  $C_O$ . This capacitor usually has a high value.  $C_O$  discharges through internal 20k $\Omega$  resistors. Depending on the size of  $C_O$ , the discharge time constant can be relatively large. To reduce transients in single-ended mode, an external 1k $\Omega$ –5k $\Omega$  resistor can be placed in parallel with the internal 20k $\Omega$  resistor. The tradeoff for using this resistor is increased quiescent current.

## AUDIO POWER AMPLIFIER DESIGN

### Design a Dual 70mW/32 $\Omega$ Audio Amplifier

|                 |                            |
|-----------------|----------------------------|
| Given:          |                            |
| Power Output    | 70 mW                      |
| Load Impedance  | 32 $\Omega$                |
| Input Level     | 1 V <sub>rms</sub> (max)   |
| Input Impedance | 20k $\Omega$               |
| Bandwidth       | 100 Hz–20 kHz $\pm$ 0.50dB |

The design begins by specifying the minimum supply voltage necessary to obtain the specified output power. One way to find the minimum supply voltage is to use [Figure 27](#) in [Typical Performance Characteristics](#). Another way, using [Equation 5](#), is to calculate the peak output voltage necessary to achieve the desired output power for a given load impedance. To account for the amplifier’s dropout voltage, two additional voltages, based on [Figure 30](#) in [Typical Performance Characteristics](#), must be added to the result obtained by [Equation 5](#). For a single-ended application, the result is [Equation 6](#).



$$V_{\text{opeak}} = \sqrt{(2R_L P_O)} \quad (5)$$

$$V_{\text{DD}} \geq (2V_{\text{OPEAK}} + (V_{\text{ODTOP}} + V_{\text{ODBOT}})) \quad (6)$$

Figure 29 indicates a minimum supply voltage of 4.8V. This is easily met by the commonly used 5V supply voltage. The additional voltage creates the benefit of headroom, allowing the LM4810 to produce peak output power in excess of 70mW without clipping or other audible distortion. The choice of supply voltage must also not create a situation that violates maximum power dissipation as explained above in [POWER DISSIPATION](#). Remember that the maximum power dissipation point from [Equation 1](#) must be multiplied by two since there are two independent amplifiers inside the package. Once the power dissipation equations have been addressed, the required gain can be determined from [Equation 7](#).

$$A_V \geq \sqrt{(P_O R_L)} / (V_{\text{IN}}) = V_{\text{orms}} / V_{\text{inrms}} \quad (7)$$

Thus, a minimum gain of 1.497 allows the LM4810 to reach full output swing and maintain low noise and THD+N performance. For this example, let  $A_V=1.5$ .

The amplifiers overall gain is set using the input ( $R_i$ ) and feedback ( $R_f$ ) resistors. With the desired input impedance set at 20k $\Omega$ , the feedback resistor is found using [Equation 8](#).

$$A_V = R_f / R_i \quad (8)$$

The value of  $R_f$  is 30k $\Omega$ .

The last step in this design is setting the amplifier's -3db frequency bandwidth. To achieve the desired  $\pm 0.25\text{dB}$  pass band magnitude variation limit, the low frequency response must extend to at least one-fifth the lower bandwidth limit and the high frequency response must extend to at least five times the upper bandwidth limit. The gain variation for both response limits is 0.17dB, well within the  $\pm 0.25\text{dB}$  desired limit. The results are an

$$f_L = 100\text{Hz}/5 = 20\text{Hz} \quad (9)$$

and a

$$f_H = 20\text{kHz} \cdot 5 = 100\text{kHz} \quad (10)$$

As stated in [External Components Description](#), both  $R_i$  in conjunction with  $C_i$ , and  $C_o$  with  $R_L$ , create first order highpass filters. Thus to obtain the desired low frequency response of 100Hz within  $\pm 0.5\text{dB}$ , both poles must be taken into consideration. The combination of two single order filters at the same frequency forms a second order response. This results in a signal which is down 0.34dB at five times away from the single order filter -3dB point. Thus, a frequency of 20Hz is used in the following equations to ensure that the response is better than 0.5dB down at 100Hz.

$$C_i \geq 1 / (2\pi * 20\text{k}\Omega * 20\text{Hz}) = 0.397\mu\text{F}; \text{ use } 0.39\mu\text{F}. \quad (11)$$

$$C_o \geq 1 / (2\pi * 32\Omega * 20\text{Hz}) = 249\mu\text{F}; \text{ use } 330\mu\text{F}. \quad (12)$$

The high frequency pole is determined by the product of the desired high frequency pole,  $f_H$ , and the closed-loop gain,  $A_V$ . With a closed-loop gain of 1.5 and  $f_H = 100\text{kHz}$ , the resulting GBWP = 150kHz which is much smaller than the LM4810's GBWP of 900kHz. This figure displays that if a designer has a need to design an amplifier with a higher gain, the LM4810 can still be used without running into bandwidth limitations.



Demonstration Board Schematic

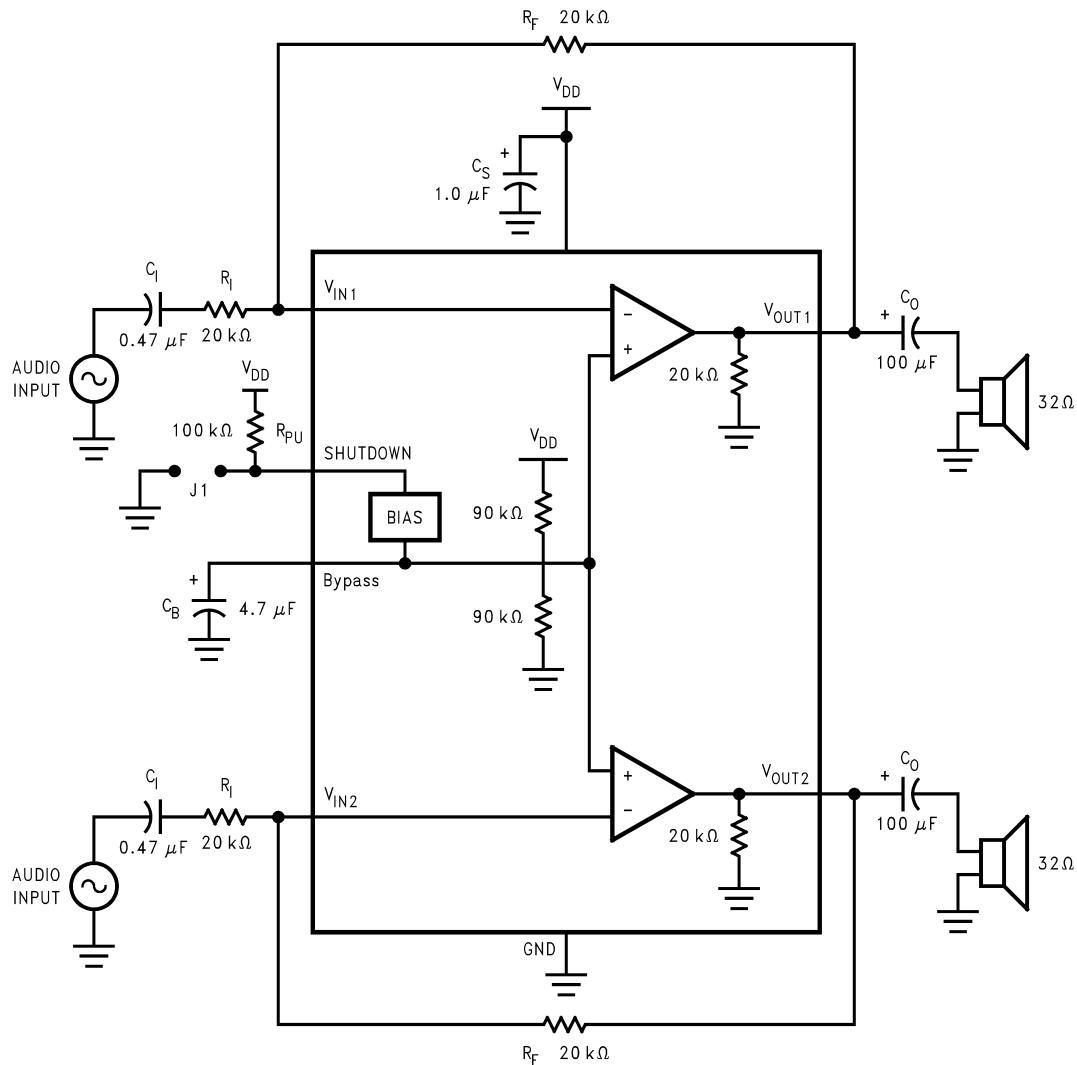

Figure 41. LM4810 Demonstration Board Schematic

Demonstration Board Layout

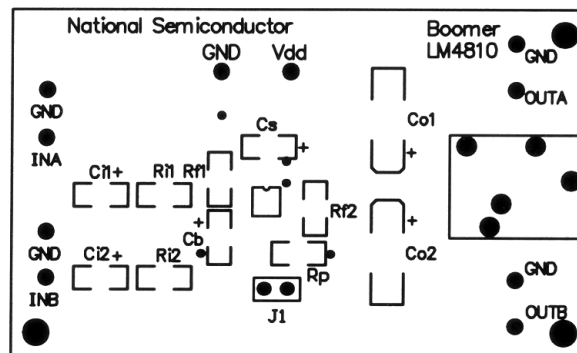

Figure 42. Recommended PC Board Layout Component-Side Silkscreen

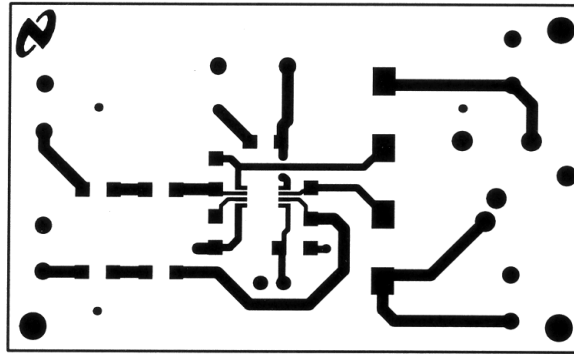

Figure 43. Recommended PC Board Layout Component-Side Layout

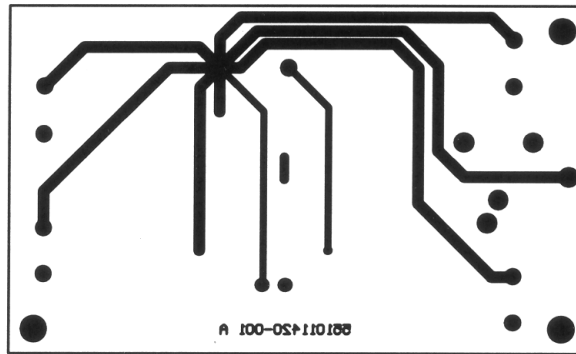

Figure 44. Recommended PC Board Layout Bottom-Side Layout

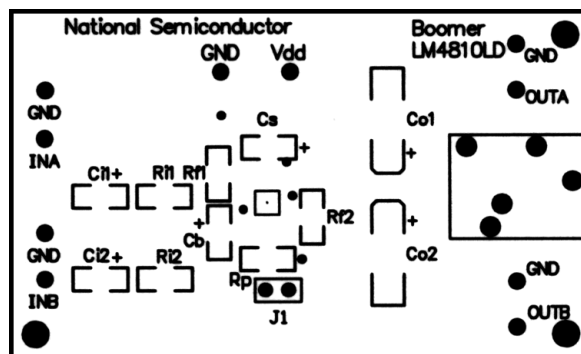

Figure 45. Recommended NGL0008B PC Board Layout Component-Side Silkscreen

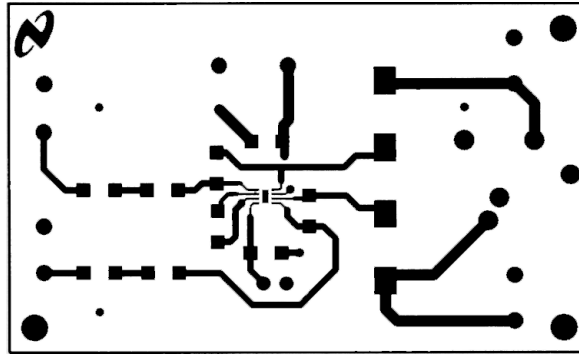

Figure 46. Recommended NGL0008B PC Board Layout  
Component-Side Layout

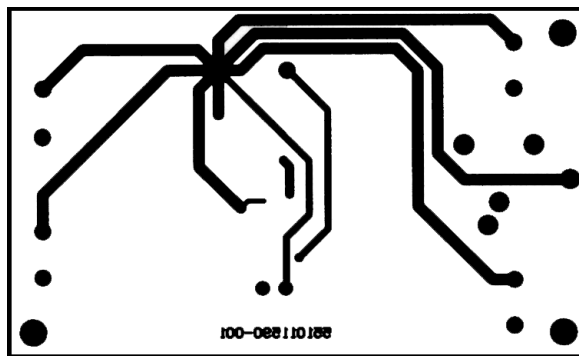

Figure 47. Recommended NGL0008B PC Board Layout  
Bottom-Side Layout

### REVISION HISTORY

| Changes from Revision C (April 2013) to Revision D         | Page               |
|--|--------------------|
| • Changed layout of National Data Sheet to TI format ..... | <a href="#">19</a> |

**PACKAGING INFORMATION**

| Orderable Device | Status<br>(1) | Package Type | Package<br>Drawing | Pins | Package<br>Qty | Eco Plan<br>(2) | Lead finish/<br>Ball material<br>(6) | MSL Peak Temp<br>(3) | Op Temp (°C) | Device Marking<br>(4/5) | Samples        |
|------------------|---------------|--------------|--------------------|------|----------------|-----------------|--------------------------------------|----------------------|--------------|-------------------------|----------------|
| LM4810MM/NOPB    | ACTIVE        | VSSOP        | DGK                | 8    | 1000           | RoHS & Green    | SN                                   | Level-1-260C-UNLIM   | -40 to 85    | G10                     | <b>Samples</b> |
| LM4810MMX/NOPB   | ACTIVE        | VSSOP        | DGK                | 8    | 3500           | RoHS & Green    | SN                                   | Level-1-260C-UNLIM   | -40 to 85    | G10                     | <b>Samples</b> |

(1) The marketing status values are defined as follows:

**ACTIVE:** Product device recommended for new designs.

**LIFEBUY:** TI has announced that the device will be discontinued, and a lifetime-buy period is in effect.

**NRND:** Not recommended for new designs. Device is in production to support existing customers, but TI does not recommend using this part in a new design.

**PREVIEW:** Device has been announced but is not in production. Samples may or may not be available.

**OBSOLETE:** TI has discontinued the production of the device.

(2) **RoHS:** TI defines "RoHS" to mean semiconductor products that are compliant with the current EU RoHS requirements for all 10 RoHS substances, including the requirement that RoHS substance do not exceed 0.1% by weight in homogeneous materials. Where designed to be soldered at high temperatures, "RoHS" products are suitable for use in specified lead-free processes. TI may reference these types of products as "Pb-Free".

**RoHS Exempt:** TI defines "RoHS Exempt" to mean products that contain lead but are compliant with EU RoHS pursuant to a specific EU RoHS exemption.

**Green:** TI defines "Green" to mean the content of Chlorine (Cl) and Bromine (Br) based flame retardants meet JS709B low halogen requirements of <=1000ppm threshold. Antimony trioxide based flame retardants must also meet the <=1000ppm threshold requirement.

(3) MSL, Peak Temp. - The Moisture Sensitivity Level rating according to the JEDEC industry standard classifications, and peak solder temperature.

(4) There may be additional marking, which relates to the logo, the lot trace code information, or the environmental category on the device.

(5) Multiple Device Markings will be inside parentheses. Only one Device Marking contained in parentheses and separated by a "~" will appear on a device. If a line is indented then it is a continuation of the previous line and the two combined represent the entire Device Marking for that device.

(6) Lead finish/Ball material - Orderable Devices may have multiple material finish options. Finish options are separated by a vertical ruled line. Lead finish/Ball material values may wrap to two lines if the finish value exceeds the maximum column width.

**Important Information and Disclaimer:**The information provided on this page represents TI's knowledge and belief as of the date that it is provided. TI bases its knowledge and belief on information provided by third parties, and makes no representation or warranty as to the accuracy of such information. Efforts are underway to better integrate information from third parties. TI has taken and continues to take reasonable steps to provide representative and accurate information but may not have conducted destructive testing or chemical analysis on incoming materials and chemicals. TI and TI suppliers consider certain information to be proprietary, and thus CAS numbers and other limited information may not be available for release.

In no event shall TI's liability arising out of such information exceed the total purchase price of the TI part(s) at issue in this document sold by TI to Customer on an annual basis.



**TAPE AND REEL INFORMATION**

**QUADRANT ASSIGNMENTS FOR PIN 1 ORIENTATION IN TAPE**

\*All dimensions are nominal

| Device         | Package Type | Package Drawing | Pins | SPQ  | Reel Diameter (mm) | Reel Width W1 (mm) | A0 (mm) | B0 (mm) | K0 (mm) | P1 (mm) | W (mm) | Pin1 Quadrant |
|----------------|--------------|-----------------|------|------|--------------------|--------------------|---------|---------|---------|---------|--------|---------------|
| LM4810MM/NOPB  | VSSOP        | DGK             | 8    | 1000 | 178.0              | 12.4               | 5.3     | 3.4     | 1.4     | 8.0     | 12.0   | Q1            |
| LM4810MMX/NOPB | VSSOP        | DGK             | 8    | 3500 | 330.0              | 12.4               | 5.3     | 3.4     | 1.4     | 8.0     | 12.0   | Q1            |

**TAPE AND REEL BOX DIMENSIONS**

\*All dimensions are nominal

| Device         | Package Type | Package Drawing | Pins | SPQ  | Length (mm) | Width (mm) | Height (mm) |
|----------------|--------------|-----------------|------|------|-------------|------------|-------------|
| LM4810MM/NOPB  | VSSOP        | DGK             | 8    | 1000 | 208.0       | 191.0      | 35.0        |
| LM4810MMX/NOPB | VSSOP        | DGK             | 8    | 3500 | 367.0       | 367.0      | 35.0        |



DGK (S-PDSO-G8)

PLASTIC SMALL-OUTLINE PACKAGE



4073329/E 05/06

- NOTES:
- A. All linear dimensions are in millimeters.
  - B. This drawing is subject to change without notice.
  - C. Body length does not include mold flash, protrusions, or gate burrs. Mold flash, protrusions, or gate burrs shall not exceed 0.15 per end.
  - D. Body width does not include interlead flash. Interlead flash shall not exceed 0.50 per side.
  - E. Falls within JEDEC MO-187 variation AA, except interlead flash.



- NOTES:
- A. All linear dimensions are in millimeters.
  - B. This drawing is subject to change without notice.
  - C. Publication IPC-7351 is recommended for alternate designs.
  - D. Laser cutting apertures with trapezoidal walls and also rounding corners will offer better paste release. Customers should contact their board assembly site for stencil design recommendations. Refer to IPC-7525 for other stencil recommendations.
  - E. Customers should contact their board fabrication site for solder mask tolerances between and around signal pads.

## IMPORTANT NOTICE AND DISCLAIMER

TI PROVIDES TECHNICAL AND RELIABILITY DATA (INCLUDING DATA SHEETS), DESIGN RESOURCES (INCLUDING REFERENCE DESIGNS), APPLICATION OR OTHER DESIGN ADVICE, WEB TOOLS, SAFETY INFORMATION, AND OTHER RESOURCES "AS IS" AND WITH ALL FAULTS, AND DISCLAIMS ALL WARRANTIES, EXPRESS AND IMPLIED, INCLUDING WITHOUT LIMITATION ANY IMPLIED WARRANTIES OF MERCHANTABILITY, FITNESS FOR A PARTICULAR PURPOSE OR NON-INFRINGEMENT OF THIRD PARTY INTELLECTUAL PROPERTY RIGHTS.

These resources are intended for skilled developers designing with TI products. You are solely responsible for (1) selecting the appropriate TI products for your application, (2) designing, validating and testing your application, and (3) ensuring your application meets applicable standards, and any other safety, security, regulatory or other requirements.

These resources are subject to change without notice. TI grants you permission to use these resources only for development of an application that uses the TI products described in the resource. Other reproduction and display of these resources is prohibited. No license is granted to any other TI intellectual property right or to any third party intellectual property right. TI disclaims responsibility for, and you will fully indemnify TI and its representatives against, any claims, damages, costs, losses, and liabilities arising out of your use of these resources.

TI's products are provided subject to [TI's Terms of Sale](#) or other applicable terms available either on [ti.com](http://ti.com) or provided in conjunction with such TI products. TI's provision of these resources does not expand or otherwise alter TI's applicable warranties or warranty disclaimers for TI products.

TI objects to and rejects any additional or different terms you may have proposed.

Mailing Address: Texas Instruments, Post Office Box 655303, Dallas, Texas 75265  
Copyright © 2021, Texas Instruments Incorporated